

**MADISON Mélangeur lavabo à 3 trous avec garniture d'écoulement - Laiton
brossé (Or 23cts)**







MADISON

20 700 360



- saillie 135 mm
- bec déverseur fixe
- jet circulaire enrichi en air
- hauteur de robinetterie 72 mm
- hauteur jusqu'au mousseur 40 mm
- diamètre de percement des robinets latéraux 32 mm
- diamètre de percement du bec 35 mm
- sans rosace
- 2x flexible de pression 1/2" x 1/2"
- débit maxi. 7 l/min
- sans plomb
- Ce produit contribue au respect des exigences des systèmes d'évaluation des bâtiments écologiques, par exemple LEED®, BREEAM®, DGNB

Convient uniquement à un lavabo avec trop-plein.

	Laiton brossé (Or 23cts)	20 700 360-28
	Chrome	20 700 360-00
	Platine brossé	20 700 360-06
	Platine	20 700 360-08
	Laiton (Or 23cts)	20 700 360-09
	Dark Platinum brossé	20 700 360-99

Accessoires recommandés



Flexibles de pression - 12 506 970 90
 • 2x flexibles de pression 3/8" x 1/2"
 x 500 mm

20 700 360
mm [inches]



Diagramme de débit



Certificats

GDV_0400288. ETA_17861. WRAS_1512009. LGA_8027.

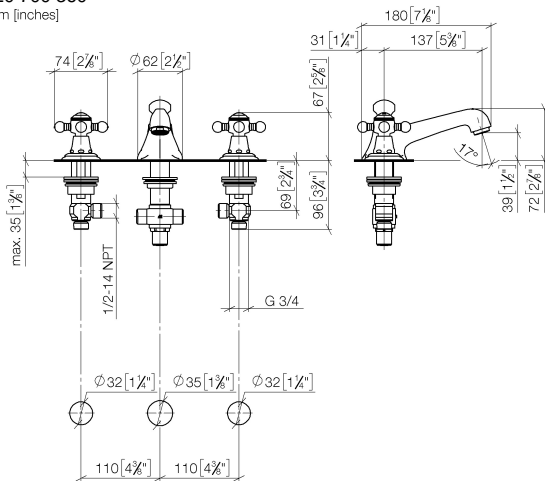
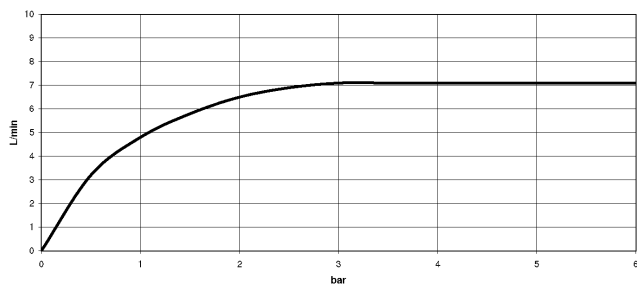
20 700 360

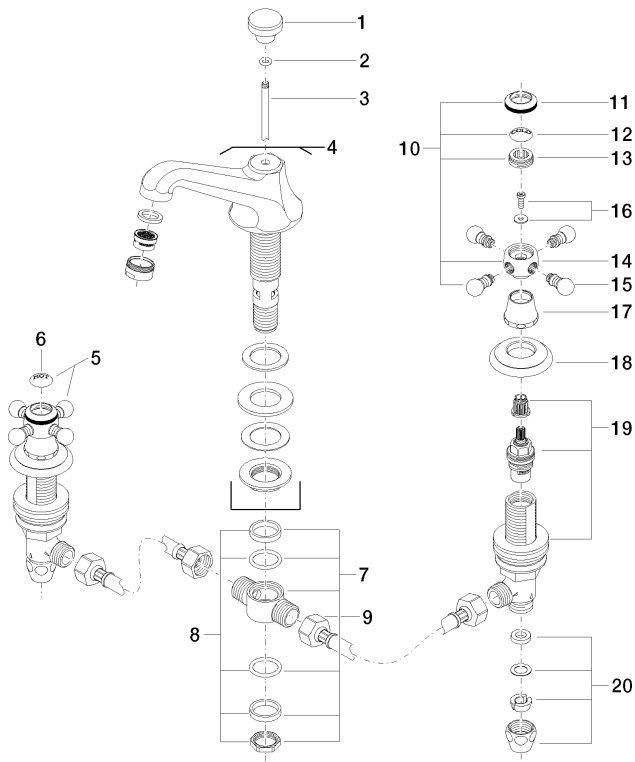

21 ———— Ablaufgarnitur 04.11.01.001.00.FP